

Language: English
Geographic Region: All
Serial Number Range: SN All



ST50 Scout

Operation and Maintenance Manual

This manual is complements of
TrackLoaderParts.com

The world's best source for ASV parts.



INTRODUCTION

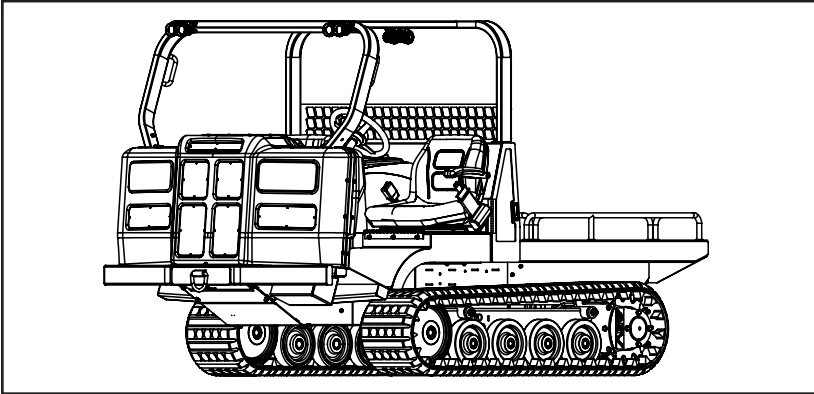

Thank you for purchasing an ASV ST-50. With this machine, you will be able to perform tasks not possible with other “light duty” machines of this nature.

The ST-50 is an industrial strength, diesel powered utility vehicle. Its rugged construction, efficient rubber track propulsion system, and high performance 2-speed hydrostatic drive enable the ST-50 to navigate a variety of challenging terrains with ease.

The scout is designed to be very safe, but safe operation also requires caution and attentiveness on the part of the operator.

There are many hazards that can be encountered during operation of an off highway utility vehicle such as the ST-50. With this in mind, it is the responsibility of each operator to read and fully understand this manual before attempting to operate the machine.

Machine damage, bodily injury, or even death may result if the procedures and precautions described in this manual are not followed closely.

Machine Orientation

Terms like **front**, **rear**, **left**, and **right** are used throughout this manual to describe portions of the machine.

They are to be understood from the perspective of an operator seated inside the cab.

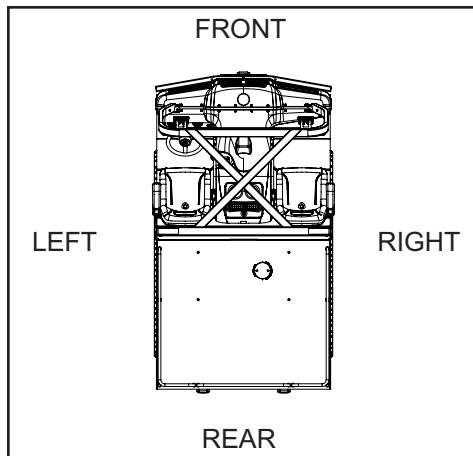



SAFETY SYMBOL

This symbol means: **Attention! Be alert!**
Your safety is involved!

A safety message will follow this symbol describing the hazard and the precautions that need to be taken to ensure your safety.

Read and understand all safety messages in order to protect yourself and others from personal injury or death.

These safety messages are identified by the words:

DANGER, WARNING, and CAUTION.



DANGER

“DANGER” refers to an imminently hazardous situation that may result in serious injury or even death.



WARNING

“WARNING” refers to a potentially hazardous situation that may result in serious injury or even death.



CAUTION

“CAUTION” refers to a potentially hazardous situation that may result in damage to the machine or its components.

The word “Note” is used throughout this manual to draw your attention to specific topics or to supplement the information provided in that section.

It is not possible to anticipate every potential hazard. The safety messages included in this document and displayed on the machine are not all-inclusive. They are intended to make you aware of potential risks and encourage a safe approach to operation, inspection and maintenance of the machine. Do not operate the machine until you are sure you have a thorough understanding of its operation, inspection and maintenance. It is your responsibility as the operator to exercise caution while performing these tasks to ensure your safety and the safety of others.



WARNING

Read and understand this manual prior to operating, inspecting, or attempting to maintain the ST-50. Performing any of these tasks incorrectly can lead to machine damage, personal injury or even death.

MACHINE IDENTIFICATION

Serial Numbers

Product ID Number (A)

The machine PIN is located between the seats on the rear wall of the cab interior. This number must be provided when contacting your dealer regarding parts, service, warranty or accessories. Warranty claims will not be processed unless the machine PIN is provided.

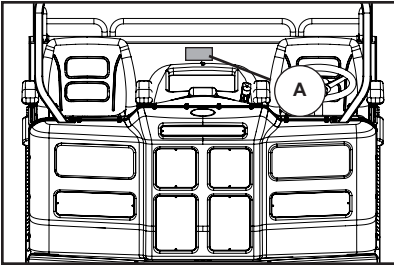

Engine Serial Number (B)

The engine serial number is located on the right side of the engine near the front, just above the injection pump.

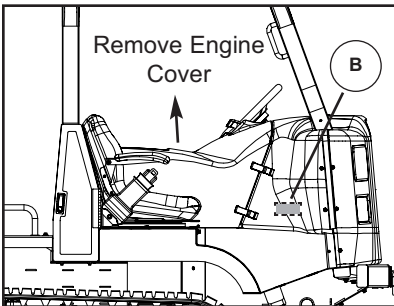

Manual Storage (C)

The machine manuals are stored in the compartment located beneath the driver's seat.

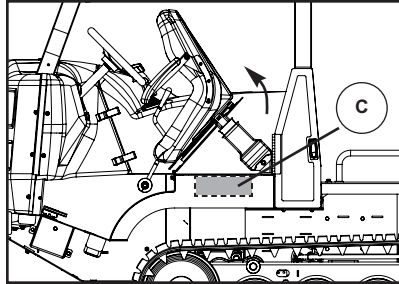

Introduction	1
Safety Overview	2
Machine Identification.....	3
Safety	6
Controls	14
Operation.....	20
Maintenance	26
Troubleshooting.....	48
Machine Specifications	51
California Proposition 65.....	52
Recommended Fluids	53
Standard Torque Guidelines	54
Service Log	55

Features 7

Cargo Bed Capacity/GVW 8

Fire Prevention 9

Warning Decal Locations 10

Warning Decals..... 11

Dump Box Brace (if equipped)..... 13

SAFETY

Features

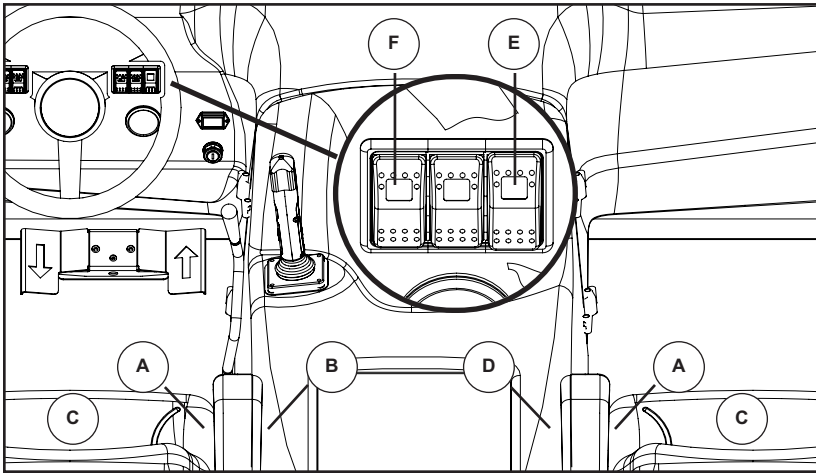

The ST-50 is equipped with many safety features to reduce the possibility of injury to the operator or passenger during operation.

These features include:

A. Seat Belts

The seat belts are designed to keep the operator and passenger (if present) securely fastened in the seats should the machine encounter uneven terrain or come to a sudden stop. Always fasten your seat belt prior to operating the machine. Serious injury or even death could result if your seat belt is left unfastened during operation.

B. Operator Seat Belt Safety Switch

The operator's seat belt is equipped with a safety switch ensuring that the operator is seated inside the machine with seat belt fastened before any motion is allowed to take place. It is enabled by the operator presence switch whenever the operator seat is occupied.

C. Operator and Passenger Presence Switches

The presence switches are activated whenever their respective seats are occupied.

D. Passenger Seat Belt Safety Switch

The passenger's seat belt is equipped with a safety switch, enabled by the passenger presence switch, that is activated whenever the passenger seat is occupied. It ensures that a passenger (if present) is seated inside the machine with seat belt fastened before any machine movement can take place.

Note: If one or both seat belts are unfastened during operation (not recommended) the machine will not come to a sudden stop (to prevent occupant injury), but when the operator does stop the machine, the motion controls will be disabled until occupant seat belts are fastened and item F is pressed.

Features/Cargo Bed Capacity/G.V.W.**E. Auxiliary Hydraulic Safety Switch (if equipped)**

This safety device has been included to ensure that attachments do not engage when the machine is started. It must be locked into its neutral position in order for the machine to start.

Note: Item E is equipped with an orange locking tab. It must be disengaged before the switch can be activated. Slide the tab downward to disengage the lock.

F. Push to Operate Switch

The ST-50 is equipped with a switch that must be depressed in order for the hydraulic controls to function. This helps to ensure that an operator fully intends to operate the machine prior to allowing track movement or attachment function to occur.

Note: Whenever the machine is turned off or if a seat belt has been unfastened during motion (not recommended) the motion controls will be disabled. You must make sure seat belts are fastened, then activate the push to operate switch (item F) to resume operation.

Cargo Bed Capacity

The bed capacity is the amount of weight that can be safely applied to the bed and carried by the ST-50.

Bed Capacity: 4000 lbs.

Note: The bed capacity specification is the total amount of weight that may be applied to the bed at any given time. This figure includes accessories that may be attached to the bed and any other materials that may be applied during operation.

Example:

Dump box weight: 750 Lbs.

Material in box: 3250 Lbs.

Total weight applied: 4000 Lbs.

Gross Vehicle Weight

The G.V.W. of the ST-50 should never exceed 9,000Lbs. during operation. This weight excludes an operator, but does include any accessories, attachments or material being moved.

Operating the machine in excess of the the G.V.W. will void the warranty.

SAFETY

Fire Prevention

Fire Prevention

The ST-50 has components that operate at high temperatures. Steps must be taken to make sure that flammable items are kept clear of these components during operation. Failure to do so may result in a fire.

The main heat sources in the vehicle are the engine and the exhaust system. The electrical system could also be a source of heat/sparks if damaged or poorly maintained.

In some work environments, flammable items may come in contact with these sources. It is very important that these flammable items be removed often from areas close to hot components. If debris is allowed to accumulate, a fire may result posing a risk to the operator and the machine. A fire can cause machine damage, severe injury or even death.

Listed are a set of precautionary tasks that should be performed daily or more often if necessary. Repair or replace worn or damaged components as needed to ensure safe machine operation.

Precautionary Tasks:

- With the engine off and cool, remove any debris present in the engine compartment. Remove the belly pans and pressure wash this area as needed to clean it properly.
- Check the battery, fuse box, electrical wiring and connection points for damage or looseness.
- Check fuel lines for leaks or damage. Never allow open flame near fuel or fuel system components.
- Check hydraulic lines, hoses and fittings for damage or leaking fluid. Never use bare hands to check for leaks. Pressurized fluid can penetrate skin and cause injury or even death.



WARNING

- **Do not use ether or any other aerosol type starting aid to start the engine.**
- **Always stop the engine and allow the machine to cool prior to adding fuel.**
- **Do not smoke or allow open flame near the machine while refueling.**

SAFETY
Warning Decal Locations

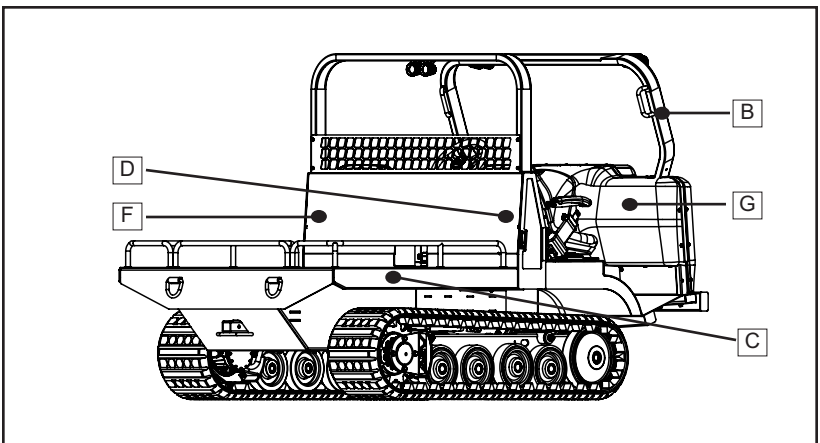
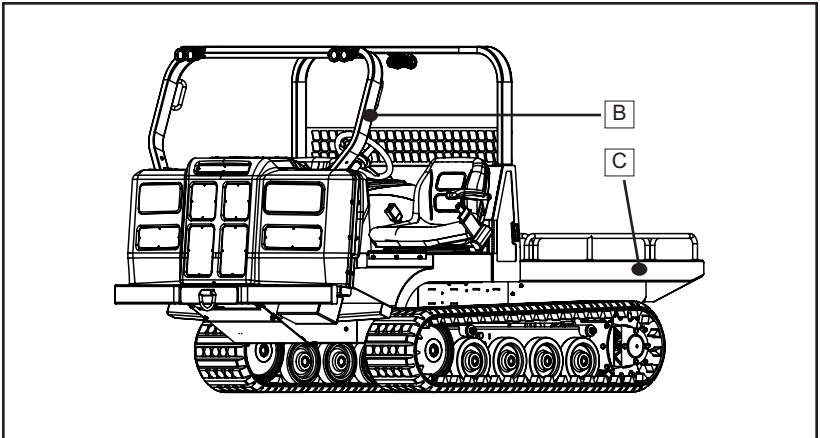
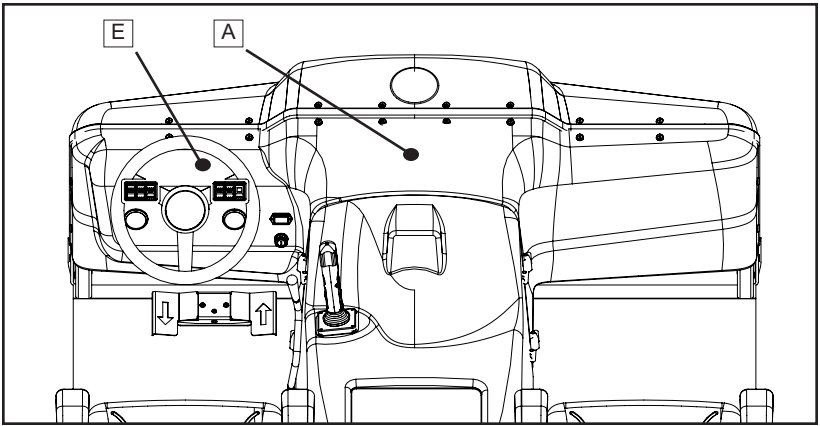

SAFETY

Warning Decals

⚠️ WARNING ⚠️				2051-678
<p>A</p> <p>Prior to Operating Read and fully understand the operation and maintenance manual prior to operating this machine.</p> <p>Operating Position Never operate the machine with any part of your body protruding out of the operator enclosure.</p> <p>Failure to do so may result in serious injury or even death.</p>	<p>Pre-Start Checklist</p> <ol style="list-style-type: none"> 1. Operator and passenger (if present) seated inside cab. 2. Seat belts fastened. 3. Auxiliary hydraulic switch in neutral position. 4. Bystanders clear of all moving components. <p>Engine Warm-Up Allow the engine to warm up to operating temperature prior to operation.</p>	<p>Vehicle Capacity 1 operator, 1 passenger. No Riders Permitted</p> <p>Carrying Loads Center loads on cargo bed and secure to prevent shifting and maximize machine stability.</p> <p>Disclaimer Failure to observe and comply with the warnings listed here may result in machine damage, personal injury, or even death.</p>	<p>Always</p> <ul style="list-style-type: none"> • Keep hands and feet inside the cab. • Watch for branches or other hazards that may enter the cab. • Keep clear of the tracks while the machine is in motion. <p>Never</p> <ul style="list-style-type: none"> • Operate the machine under the influence of drugs or alcohol. • Operate in excess of GVW rating. (see o&sm manual) 	

Keep away from tracks while machine is in motion. Serious personal injury or even death may result.

Inspect undercarriages daily for accumulation of debris. Build-up of debris may shorten component life and decrease machine performance.

2046-467

WARNING

CAUTION

C

⚠️ WARNING ⚠️		2051-684
<p>The ROPS enclosure may not protect occupants in all foreseeable accidents including, but not limited to rollover.</p>		

⚠️ CAUTION ⚠️	
<p>Load Management</p> <p>When hauling cargo, always position the load so that it is centered on the bed and orient it so that it rides as low as possible to maximize machine stability. Properly secure all loads prior to operation.</p> <p>Failure to observe or comply with precautionary notices may result in machine damage, serious injury or even death.</p> <p style="text-align: right; font-size: small;">2051-700</p>	

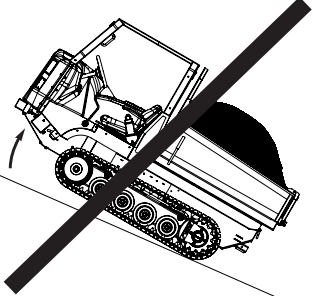
E	WARNING	▲
		
<p style="text-align: center;">Operating with a Load</p> <p>The Scout's operating characteristics can change dramatically when carrying a load. Terrain and maneuvers that are considered safe when operating an unloaded machine may not be safe when carrying a load.</p> <p>Avoid inclines or side-hills when operating with a load. Loads, especially liquids, can shift when traversing uneven terrain. If the load shifts during operation, it can drastically alter the machine center of gravity and may result in a roll-over. A roll-over can cause machine damage, serious injury, or even death.</p> <p>Always carry loads low and as close to the center of the machine as possible. Operate on level ground whenever possible. 2052-014</p>		

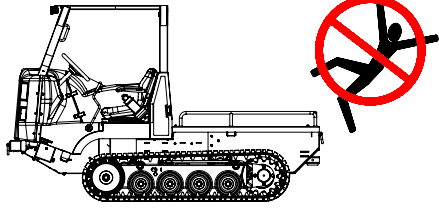
F	CAUTION	▲
<p style="text-align: center;">CARGO BED CAPACITY</p> <h2 style="text-align: center;">4000 lb. (1814 kg)</h2> <p>Do not load the cargo bed in excess of the the cargo bed capacity rating. Carrying loads in excess of this rating will void the warranty.</p> <p>Failure to observe or comply with precautionary notices may result in machine damage, serious injury or even death.</p>		
WARNING		
		
<p style="text-align: center;">No Riders</p> <p>This vehicle is designed to carry one operator and one passenger seated inside the operator enclosure with safety belts fastened. Never allow additional passengers to ride in or on the machine.</p> <p>Failure to observe or comply with warnings may result in serious injury or even death. 2051-699</p>		

G	WARNING	▲
<p>Vehicle Capacity 1 operator, 1 passenger. No Riders Permitted</p>	<p style="text-align: center;">Always</p> <ul style="list-style-type: none"> • Keep hands and feet inside the cab. • Watch for branches or other hazards that may enter the cab. • Keep clear of the tracks while the machine is in motion. 	
<p>Passenger Position</p> <ul style="list-style-type: none"> • Seated in passenger seat. • Seat belt fastened. • Hands/feet inside cab. 	2051-679	

SAFETY

Dump Box Brace (if equipped)

Dump Box Brace

The ST-50 is available with a dump box attachment. The dump box brace (A) is a device used to mechanically support the weight of the box when in the raised position.

The dump box brace is intended to keep personnel safe should they need to work on the machine with the dump box in the raised position. It is not safe to rely on the hydraulic system to support dump box weight just as it is not safe to crawl under a machine supported only by a hydraulic jack. The dump box brace is used to support the weight of the dump box much like jack stands are used to mechanically support vehicle weight.



WARNING

Do not work on or near a machine with the dump box in the raised position unless the dump box brace has been correctly installed.

To install the dump box brace:

1. Remove any load from the dump box (empty the box).
2. Park the machine on level ground in a safe area for performing service work.
3. Make sure any bystanders are clear of the dump box, then raise it to the upper limit.

4. Have an assistant pivot the brace into position under the box.
5. Lower the dump box slowly until it comes to rest on the brace.

The brace is in place. You may now safely turn the engine off and exit the machine.

To remove the brace:

1. Start the machine and raise the dump box until it is clear of the brace.
2. Have an assistant lower the brace until it rests on the cargo bed.
3. Once the brace has been stowed and the assistant is clear, lower the dump box to the cargo bed and turn the engine off to complete the procedure.

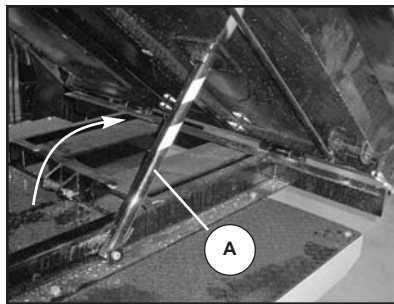

Switch Panels/Instrument Display	15
Motion Controls.....	16
Throttle/Two Speed	17
Auxiliary Hydraulics.....	18

CONTROLS

Switch Panels/Instrument Display

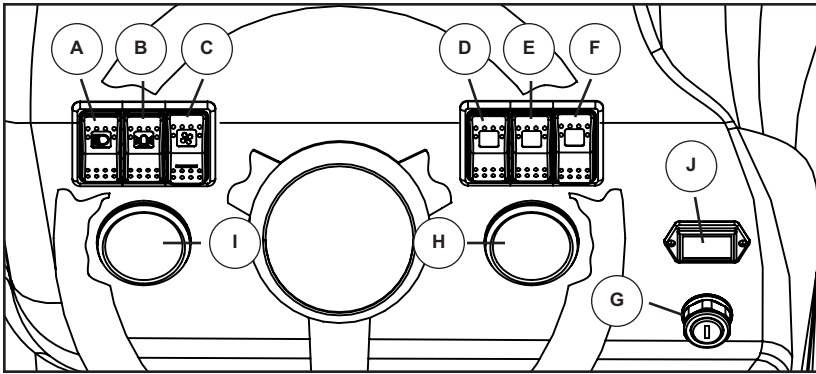

There are many instruments and switches involved in the normal operation of the ST-50. Make sure to learn the location and function of each of these items prior to operating your machine.

Switch Panels

- A. Headlight Activation Switch
- B. Beacon Activation Switch*
- C. Heater Fan Activation Switch*
- D. Push To Operate Switch
- E. 2-Speed Activation Switch
- F. Continuous Flow Switch*
- G. Ignition Switch

Instrument Display

- H. Fuel Level Gauge
- I. Warning Light Display
- J. Hour Meter
- K. High Range Indicator
- L. Glow Plug Operation Indicator
- M. Oil Pressure Warning Light
- N. Coolant Temp. Warning Light
- O. Hyd. Oil Temp. Warning Light
- P. Battery Voltage Warning Light

Optional equipment is indicated by an asterisk. *

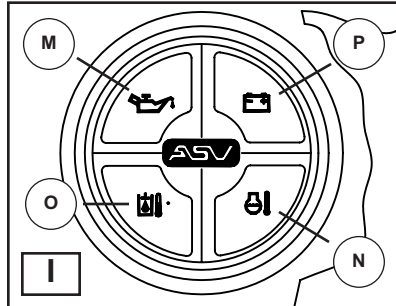
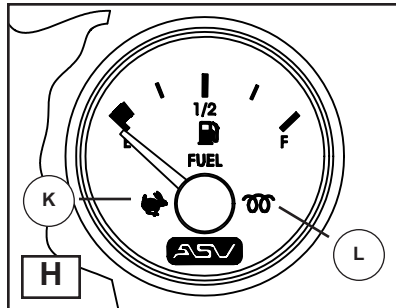

The glow plug operation light should illuminate only when the ignition switch is turned to the pre-heat position.

	CAUTION
<p>Should item(s) M, N, or O illuminate during operation, shut the machine down immediately. Diagnose and make any necessary repairs before resuming operation.</p>	

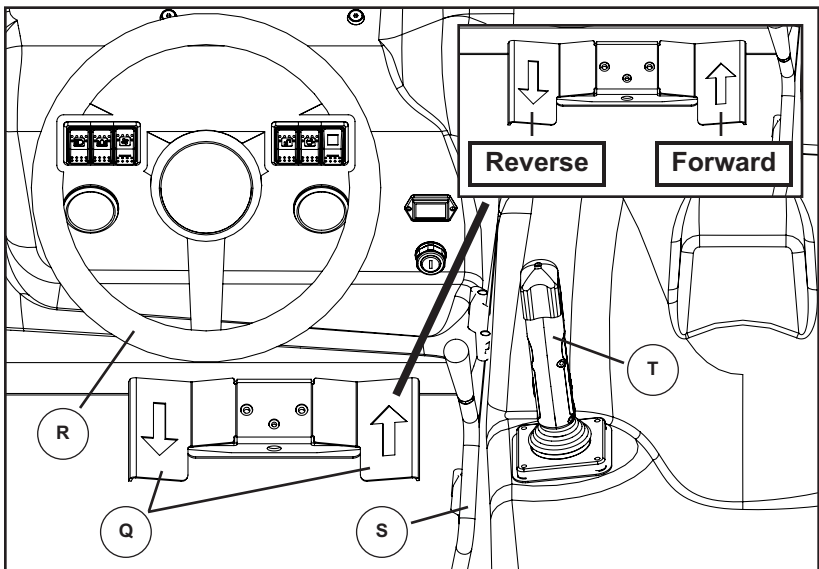

Motion Controls (and related)

Q. Bi-Directional Speed Control

R. Steering Control (wheel)

S. Throttle Control

T. Attachment Control

Steering Control

The ST-50 is equipped with a steering wheel (R) to direct machine movement.

- To turn the vehicle to the right, rotate the wheel clockwise.
- To turn the vehicle to the left, rotate the wheel counter-clockwise.

Note: The machine must be in motion for the steering control to function.

The amount the wheel is rotated determines the degree to which the machine turns/pivots. The farther you turn the wheel in a given direction, the tighter the machine turns.

Bi-directional Speed Control

The scout is equipped with a foot pedal (Q) that controls both machine speed and movement in forward/reverse directions.

- To move the machine forward, press the right side of the pedal gently towards the floor.
- To move the machine backward, press the left side of the pedal gently towards the floor.

Machine speed is determined by how far the pedal is pressed towards the floor. This applies in forward and reverse directions.

- To move the machine slowly press the pedal only slightly closer to the floor then hold to maintain desired speed.
- To move the machine at a faster rate, press the pedal farther toward the floor until your desired speed is reached and hold position to maintain speed.

CONTROLS

Throttle/Two Speed

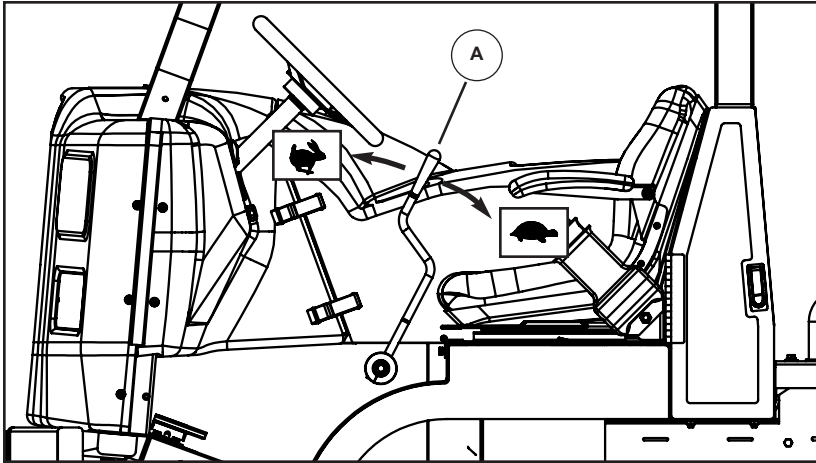

Throttle Control

The throttle (A) controls engine speed (RPM). When performing work that requires delicate, precise movements, use a lower RPM. When more speed, power, or flow is required, use a higher RPM.

The ST-50 is equipped with a hand operated throttle mechanism.

- To increase engine RPM, move the hand lever forward until the desired RPM has been reached.
- To decrease engine RPM, move the hand lever rearward.

Two Speed

The ST-50 is equipped with a two speed hydrostatic drive system that provides high and low range capability.

- **Low range** is best suited for strenuous tasks, maneuvering through tight areas, or traversing rough terrain.

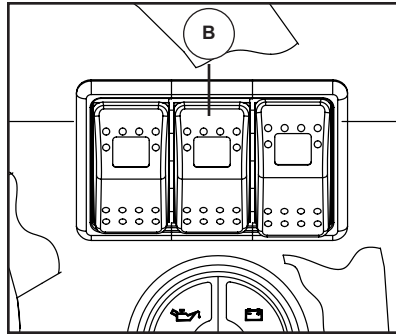

- **High range** is best suited for open areas with even terrain where obstacles are easily seen and avoided.

To activate high range, press the two speed activation switch (B) located in the right switch cluster on the instrument display.

There is a high range indicator light in the fuel gauge to the left of the needle pivot. This light illuminates when high range operation is activated.

Note: When shifting between ranges, slow the machine down to ensure a smooth transition.

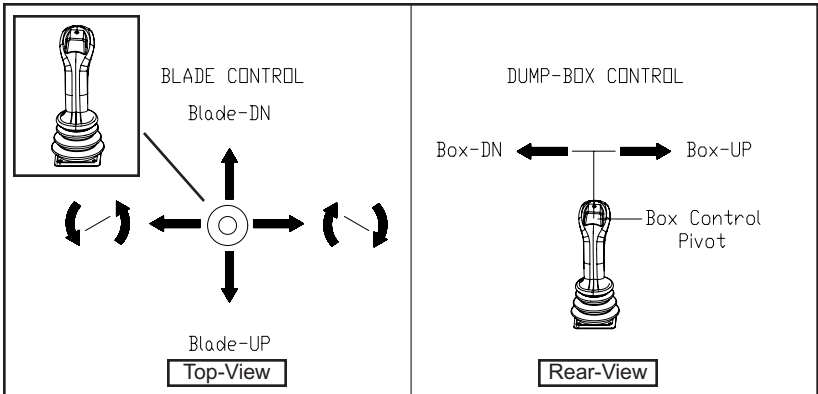

Intermittent Flow Hydraulics (optional)

The ST-50 (if equipped) has the capability to accept intermittent style attachments like a dump box or blade. These are controlled with the joystick style attachment control (C).

Note: The operator must be seated in the cab with seat belt fastened in order for the attachment control (C) to function.

The illustration above shows the relationship between joystick and attachment movement.

The ST-50 is equipped with a float function that can be used with the blade attachment. Float allows the blade to follow the contours of the ground as you move with only its own weight acting as downforce.

To engage float:

- Pull the trigger on the front of the joystick control.

To disengage float:

- Gently pull back on the joystick until the blade moves upward.

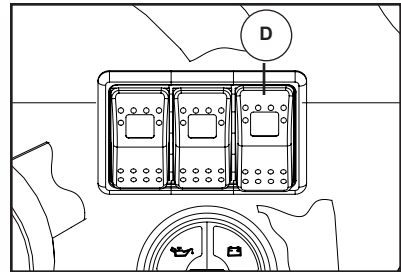
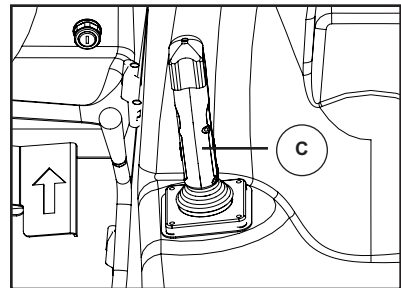

Continuous Flow Hydraulics (optional)

The ST-50 is available with a continuous flow system that can be used to operate continuous flow style attachments.

To activate continuous flow, press the continuous flow switch (D) located in the right switch cluster in the instrument display.

Flow direction is controlled (reversed) by pressing the top or bottom of the switch as required.

CONTROLS

Auxiliary Hydraulics

Auxiliary Hydraulics

The auxiliary hydraulics are governed by controls in the machine circuitry that limit operation to certain conditions.

Intermittent Flow:

- The operator must be seated in the cab with his/her seat belt fastened in order for the intermittent flow hydraulics to operate.

Continuous Flow:

- The continuous flow switch must be locked in its neutral position in order to start the machine.
- The operator is not required to be seated in the cab for the continuous flow hydraulics to operate.
- In the event that the operator exits the cab while the continuous flow hydraulics are in operation, flow will cease. You must reactivate the continuous flow switch to resume operation.

Pre-Operation..... 21

Starting Procedure 22

Operation Techniques 23

Cargo Bed Safety..... 25

OPERATION

Pre-Operation

Pre-Operation Safety Check

Before operating the machine, perform a safety check to identify any items that may affect safe operation.

Check to make sure:

1. Engine compartment, chassis and coolers are clean and free of debris. (see page 30)
2. Windows (if equipped) and lights are clean and unobstructed.
3. Both the operator and passenger seat compartment latches are fastened.
4. Tracks are in good condition.
5. Track tension is correctly adjusted.
6. All fluids are filled to appropriate levels.
7. Battery cables are in good condition and securely fastened.
8. Engine accessory belts are in good condition and properly tensioned.
9. Hydraulic hoses and fittings are in good condition.
10. Continuous flow switch is in its neutral position.
11. Engine cover is latched in place and bystanders are clear of all moving parts.
12. All grease points have been properly lubricated.

Note: The parking brake is automatically on/activated when:

- the machine is turned off.
 - the machine is started until the push to operate switch has been pressed.
 - the operator or passenger has not yet fastened his/her seat belt.
 - the operator brings the machine to a stop after either occupant unfastens his/her seatbelt during operation.
-

Starting Procedure

Upon completion of the pre-operation safety check, if all items are in compliance, the machine is ready to be started.

To start the machine:

1. Enter the machine.
2. Sit down into the operator seat then fasten your seat belt securely around your lower abdomen.

Note: The operator and passenger (if present) must be seated in the cab and have seat belts fastened for motion to occur.

3. From the slow position (turtle icon), move the throttle to 1/3 open by moving the hand lever forward (toward the rabbit icon) approximately 1/3 of its travel.
4. Insert the key into the ignition switch and turn it to the left for approximately six seconds to pre-heat the engine. During this time, the glow plug operation light (in the fuel gauge) will illuminate.
5. Once the engine has been pre-heated, turn the key to the right and hold to start the engine. Release the key as soon as the engine fires.

6. Once running, reduce throttle to a low idle by slowly pulling back on the hand lever. Allow the engine to idle for approximately 5 minutes to allow it to reach operating temperature.
7. Once the engine has reached operating temperature, set desired engine speed (RPM) by moving the hand lever forward into position.
8. Press the push to operate switch to release the parking brake.

The machine is now ready for operation.



WARNING

- Failure to fasten your seat belt could result in serious injury or death.



WARNING

- Do not use ether or any other aerosol type starting aid to start the engine. Explosion may result.



CAUTION

- Do not crank the engine for more than 20 seconds. Allow the starter to cool for two minutes before cranking again.

OPERATION

Operation Techniques

Overview

Operating the ST-50 is intended to be as safe and simple as possible. The controls section of this manual covers the various controls used to operate the machine. Each operator should take the necessary time to familiarize him/herself with the controls section of this manual prior to attempting to operate the machine.

In order to learn to properly operate the machine, it is very important that each operator read and understand this manual thoroughly. It is also very important to take the necessary time to become skilled in operation techniques in accordance with the instructions in this section. Do this in an open area that is free of potential hazards and bystanders. This will give the operator space to practice without worry of injuring people or damaging property including him/herself and the machine.

The ST-50 is designed to accommodate the operator and one passenger. The operator and passenger must wear seat belts at all times during operation. Never carry additional passengers on the cargo bed or in the optional dump box.

Always use caution while operating the ST-50. Watch for and avoid objects or obstacles that may damage the machine or cause injury. Avoid terrain that appears unsafe or unstable.

Operating the ST-50

Once all of the pre-operation checks have been performed. Start the engine according to the procedure on page 22. At this point, the operator and passenger (if present) are seated inside the cab with seat belts fastened, the engine is at operating temperature and the desired operating RPM is set. Press the push to operate switch to activate the motion controls. The ST-50 is now operational.

Forward Operation

Begin by slowly and smoothly pressing the right side (forward arrow) of the bi-directional speed control. The machine will begin moving forward. Adjust pedal pressure as necessary to regulate machine speed. Familiarize yourself with the steering control by turning gradually both to the right and left making sure to stay clear of any obstacles. In this way, familiarize yourself with the ST-50's handling and operating characteristics. Do not operate the ST-50 in high range until you are thoroughly familiar with the controls and are confident in your ability to operate at slower speeds.

Reverse Operation

To operate the machine in reverse, press the left side (rearward arrow) of the bi-directional speed control pedal towards the floor slowly and smoothly until the desired operating speed has been reached.

Stopping the ST-50

At any time, you may stop the machine by slowly lifting your foot off of the directional control foot pedal.

Turning the ST-50

The ST-50 must be in motion in order to turn or pivot. Once in motion, turn the ST-50 by rotating the steering wheel to the left (CCW) or right (CW) as needed to avoid obstacles. The farther you turn the wheel in a given direction, the tighter the turning radius becomes.

Hill Side Operation

By design, ASV rubber track vehicles are very stable on inclines. Machine weight is distributed well throughout the chassis and the suspended undercarriage track system provides excellent traction and floatation on most surfaces.

Even with these capabilities, caution should always be exercised while operating the ST-50 on an incline. Never operate the ST-50 on an incline in excess of 20° (standard machine, no load). Do not make sudden changes in direction and move slowly to maximize machine stability.

When turning on an incline, back down the hill while slowly turning until the machine is pointed in the desired direction, then proceed forward.

Operating On Turf

ASV rubber track vehicles are designed to tread lightly and produce minimal ground disturbance while operating on finished surfaces like turf, however, care should be taken while operating on these surfaces to prevent blemishes from occurring.

Turning poses the greatest risk of surface disturbance during operation. Moving in a straight line across turf will cause little or no disturbance, whereas tight cornering will most likely cause blemishes.

While working on turf, make gradual turns. (see item A) If space is limited, turn gradually by moving back and forth until facing the desired direction. (see item B)

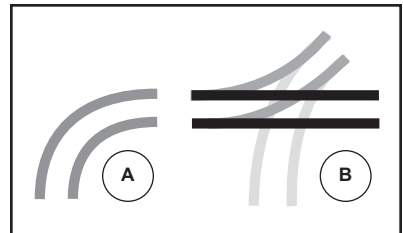

OPERATION

Cargo Bed safety

Cargo Bed Safety

The cargo bed is designed to carry loads and accommodate various attachments.

It is important to know some basic safety guidelines for applying and carrying loads on the cargo bed to maximize operator and passenger safety during operation.

Guidelines:

- Always secure loads to the bed to prevent load shifting, spillage, or damage during operation.
- Carry loads as close to the center of the machine as possible and orient them so that they ride as low as possible to maximize machine stability while in motion.
- When carrying loads, always use extra caution. Move slowly and avoid steep inclines, rough terrain, and obstacles that may cause the load to shift or spill.



WARNING

The ST-50's operating characteristics can change dramatically when carrying a load. Terrain and maneuvers that are considered safe when operating an unloaded machine may not be safe when carrying a load.

Avoid inclines or side-hills when operating with a load. Loads, especially liquids, can shift when traversing uneven terrain. If the load shifts during operation, it can drastically alter the machine center of gravity and may result in a roll-over. A roll-over can cause machine damage, serious injury, or even death.

Always carry loads low and as close to the center of the machine as possible. Operate on level ground whenever possible.

Precautions/Safety Warnings	27
Jacking Procedure	28
Maintenance Schedule	29
Radiator/Oil cooler/Engine Cleaning.....	30
Air Cleaner	31
Fuel Filter.....	32
Engine	33
Electrical	36
Hydraulic System.....	37
Undercarriages.....	38
Drive Sprocket Rollers	46

MAINTENANCE

Precautions/Safety Warnings

Precautions

The ST-50 requires periodic maintenance to ensure intended performance and prevent costly down time. When service is required, ASV recommends that all work be done by an authorized ASV dealer.

If you perform maintenance on your own machine, you should familiarize yourself with the information provided in this section on general maintenance. Incorrect or incomplete maintenance may cause improper or unsafe vehicle operation.

Problems caused by incomplete or improper maintenance are not eligible for warranty coverage.

Safety Warnings

Exercise caution when performing maintenance or service work on your machine. Serious injury may result if the following guidelines are not followed.

- Always select a safe area to perform maintenance.
- Always select the proper tools for the work to be performed.
- Never work on a machine supported only by a jack. Always use ASV approved jack stands to support vehicle weight while performing maintenance or service work.
- Remove any attachments prior to working underneath the machine.
- Never run the engine in a poorly ventilated area. Exhaust fumes are fatal when inhaled in sufficient quantities.
- Never smoke or allow open flame near flammable liquids or the battery. Fire or explosion may result.
- Always allow the machine to cool before performing maintenance work. Engine, hydraulic, exhaust, and cooling system components become very hot during operation and may cause burns if not allowed to cool sufficiently.
- Do not spill flammable liquids on hot engine components. Fire may result.
- Do not perform maintenance on a machine with the engine running unless instructed to do so by the machine specific ASV service manual. Moving engine parts pose a safety risk and can cause injury or death if proper precautions are not taken.

Jacking Procedure

Occasionally, the ST-50 may need to be suspended off of the ground to perform maintenance. Exercise caution when jacking the machine. Always use a jack that is capable of lifting the machine and support machine weight with ASV approved jack stands during service. Never work on or under a machine supported only by a jack.

To safely jack the ST-50:

1. Remove any attachments fastened to the machine or loads placed on the cargo bed.
2. Roll or slide your jack under the front of the machine and center the lifting pad directly beneath the center of the front torsion axle.
3. Once in place, jack the machine upwards making sure it remains stable until it has reached sufficient height to install an ASV jack stand beneath the machine.
4. Slide the jack stand into place making sure it is centered under the machine (left to right when viewed from the front) and far enough back for the machine to remain stable when the jack is lowered and the front of the machine rests on the stand.
5. Once the stand is in place, slowly lower the machine onto the stand, then remove the jack.

Repeat steps 2-5 at the rear of the machine should both ends of the machine need to be off of the ground for maintenance or service.



CAUTION

- **Lift the machine under the torsion axles only! Jacking the machine at any other place may cause damage.**



MAINTENANCE Schedule

<u>Maintenance Item</u>	<u>Service required</u>	<u>Interval</u>	<u>Notes</u>	<u>Service Capacity</u>
Grease fittings	Lubricate	Daily	(Torsion Axle Pivots)	
Fluid levels	Check	Daily	Adjust levels as necessary.	
Fan belt tension	Check	Daily	Adjust tension as necessary.	
Fan belt condition	Inspect	Daily	Replace if worn or damaged.	
Water separator	Drain	Daily		
Track condition	Inspect	Daily	Replace if severely damaged.	
Track tension	Inspect	Daily	Adjust tension as necessary.	
Air cleaners	Inspect	Daily	Replace if damaged or heavily soiled.	
Radiator/oil cooler fins	Inspect	Daily	Clean often (as necessary).	
Undercarriages	Inspect	Daily	Clean often (as necessary).	
Engine compartment	Inspect	Daily	Clean often (as necessary).	
Drive sprocket rollers	Inspect	50 hr.	Replace if damaged or worn. (35% min.)	
Engine oil and filter	Replace	12 Mo. or 500 hr.	Harsh conditions (6 Mo./250 hr. interval)	11.2 qt.
Hydraulic filter	Replace	250 hr.	Located in hydraulic tank (access in bed)	
Hydraulic oil	Replace	500 hr.	Service refill capacity only.	5.125 gal.
Fuel filter	Replace	500 hr.	Replace fuel filter element.	
Radiator coolant	Replace	3000 hr.	Coolant with SCA additive required.	1.75 gal



Radiator/Oil Cooler

The radiator and oil cooler must be kept clean to ensure proper operation. Engine and hydraulic system overheating, damage and even failure can result if the radiator/oil cooler is not kept clean. A pressure washer or compressed air nozzle work well to blow debris clear of the fins in the radiator/oil cooler.

Note: If hydraulic oil or engine coolant warning lights illuminate during operation, increase cleaning intervals.

To clean radiator/oil cooler:

1. Make sure the engine is **off and cool**, then remove the front fascia to access the radiator/oil cooler.
2. Using compressed air or a pressure washer, thoroughly clean the radiator/oil cooler as shown.

Note: Make sure to keep the water nozzle at least 12" (8" for air) away from the cooler and that the spray is directed straight through the cooler. This will prevent the cooling fins from being bent over which will decrease cooling performance.

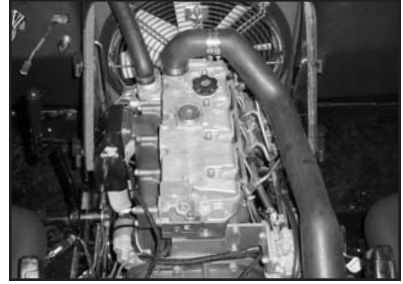

Engine

Periodic cleaning of the engine compartment is also recommended to maintain safe and reliable operation. Clean as needed.

1. Remove the forward belly pans (2) from under the engine.
2. Remove the engine cover.
3. Pressure wash any debris from the engine compartment and chassis area out through the lower opening.

MAINTENANCE

Air Cleaner

Air Cleaner

The ST-50 is equipped with two air filter elements that remove contaminants from the air drawn into the engine. Regular inspection and replacement is necessary to ensure proper performance and to prolong engine life.

To remove and inspect the air cleaner elements:

1. Turn the engine off.
2. Open the passenger side access door on the rear console enclosure (behind the seats) to access the air cleaner housing.
3. Release the latches securing the cover (A) to the air cleaner housing, then rotate the bottom of the cover (rubber boot) upward past the metal plate housing the filler openings. Slide the cover out face down between the door latch tab and the filler caps to remove it from the machine.
4. Remove the primary element (B) and inspect it. If it appears damaged in any way, replace it. If the element is heavily soiled, replace it. If it appears to be in good condition, clean the element (if necessary) and reinstall it.
5. Once the primary element has been removed, the secondary element (C) will be visible. Remove the element and inspect it. If it appears damaged or heavily soiled, replace it.

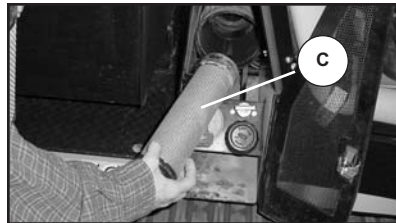
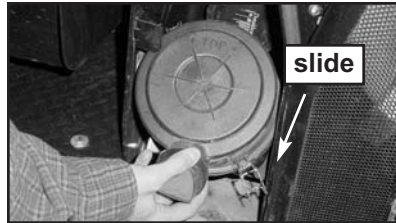
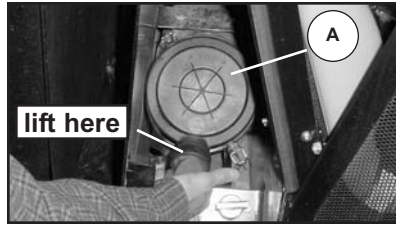

6. Install the new, or clean used elements into the housing as found upon removal.
7. Reverse steps 2 and 3 to reinstall the housing cover.

Note: The secondary element is not serviceable. It should be replaced after three cleanings of the primary filter.

Note: The primary element may be cleaned and reused up to five times if properly maintained, but should be replaced at least once a year.

Primary Element Cleaning Procedure

1. Remove loose dirt from the filter element with compressed air or a water hose.

Compressed air: 100 P.S.I. maximum with a 1/8" nozzle at least 2" away from the the filter.

Water: 40 P.S.I. maximum without a nozzle.

2. Soak the filter in a non sudsing detergent solution for at least 15 minutes moving it gently through the solution to further clean the element. Never soak for more than 24 hours.
3. Rinse the filter thoroughly with a gentle stream of water to remove all dirt and remaining detergent.
4. Allow the filter to dry completely before reinstalling it into the machine.



CAUTION

Do not use any heat source other than warm air at less than 160° F to dry the filter.



CAUTION

Do not clean the air filter elements while the engine warranty is in effect. During the warranty period, ASV recommends replacing the elements instead of cleaning them. Heavy-duty air filter manufacturers will not warrant the air filter once it has been cleaned.

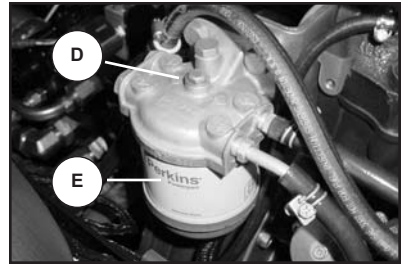

Fuel Filter

The fuel filter removes contaminants from the fuel as it enters the engine for combustion. Over time, the filter can become plugged and may cause the engine to lose power, run roughly or fail to start. The fuel filter should be replaced every 500 hours or more often as necessary to prevent these conditions from occurring.

To change the filter:

1. Thoroughly clean the outside of the filter assembly to reduce the chance of contaminants being introduced into the fuel system.
2. Loosen the retaining bolt (D) then remove the filter element (E) from the filter head and dispose according to local mandates and regulations.
3. Reinstall the filter assembly by reversing step 2.

MAINTENANCE

Engine

Engine Oil / Filter Change

Regular oil changes are necessary to maintain a strong running engine. The normal interval between oil changes is 500 hours or one year. Machines that are operated under harsh conditions should have the oil and filter changed more frequently. ASV recommends an interval of 250 hours or six months for machines that are operated under these conditions. Harsh conditions may include: continuous high load applications, operation in high temperatures, or abnormally dusty, dirty conditions.

To change the oil and filter:

1. Start and warm the engine for a few minutes to warm the oil, then turn the engine off and remove the key from the ignition to avoid accidental start.
2. Remove the belly pan beneath the engine. (fig. 1)
3. Place a suitable container beneath the rear drain plug and filter to catch the used oil as it drains.
4. Remove the drain plug from the oil pan and allow the oil to drain completely from the engine. Use the correct size wrench to keep the plug in reusable condition. (fig. 2)
5. Remove the engine oil filter by hand or with a strap wrench if necessary. (fig. 3)

6. Once the filter has been removed make sure the old rubber gasket is present on the filter. If it is not on the old filter, check the filter head (engine). If it is still there, remove it prior to installing the new filter.

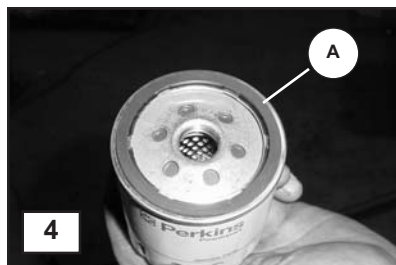
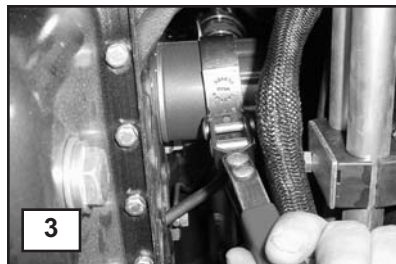
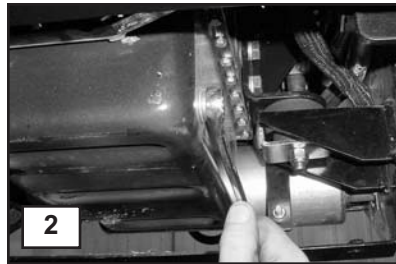
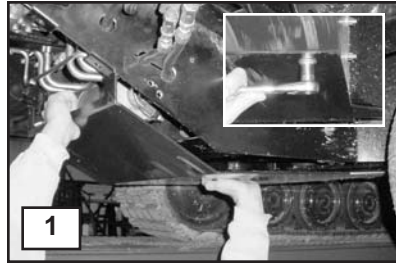



CAUTION

If the oil filter gasket (A) is not removed from the filter head and the new filter is installed on top of it, an oil leak will result when the engine is started. If unnoticed, the engine may run itself out of oil causing engine failure. (fig. 4)



7. Prepare the new filter for installation by rubbing fresh oil onto the exposed surface of the rubber filter gasket.
8. Thread the new filter onto the filter head. Tighten the filter by hand as instructed by the label located on the filter or filter box.
9. Re-install the drain plug and tighten to secure it in place.
10. Remove the oil filler cap and fill the engine crankcase with ASV 10W-30 Heavy Duty Engine Oil. (capacity: 11.2 U.S. quarts including filter). (fig. 5)
11. Install the oil filler cap.
12. Perform a visual inspection to make sure the drain plug, filter, and oil filler cap are in place and tight.
13. Start the engine and watch the oil pressure indicator light in the warning light display. The light should come on, then go out when oil pressure has been achieved. If the light doesn't go out, turn the engine off immediately and look for potential problems. If the light does go out as expected, oil pressure has been achieved.
14. Once the engine is running, perform a visual inspection to make sure there are no leaks or other visible/audible problems.
15. If everything looks as it should, turn the engine off, reinstall the belly pans and perform the oil level check procedure on page 35.

Engine

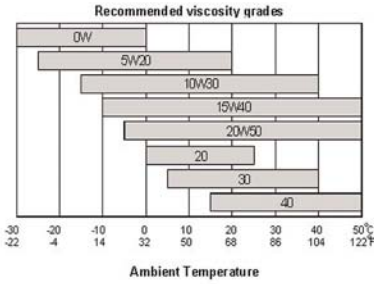

Engine Oil Specifications

Use ASV 10W-30 Heavy Duty Engine Oil for most conditions. In the event of an alternate working environment, the chart above may be used as a guide to oil viscosity grades.

You may also use a quality engine oil substitute meeting the following minimum specification:

- API CH-4 multigrade engine oil.

Oil Level Check

To check the oil level:

1. Park the machine on level ground.
2. Remove the engine cover to gain access to the engine compartment.
3. Locate and remove the engine oil dipstick (A) from its tube.
4. Wipe the dipstick with a clean shop cloth and re-insert it into the tube until it comes to rest in its seated position.
5. Remove the dipstick once again and inspect the end for oil on the level indicator.

6. Oil should be present on the dipstick up to, but not over the upper (full) level indicator notch. If the level is correct, re-install the dipstick and then reinstall the engine cover to complete the procedure.
7. If the level is low, add the proper grade and viscosity engine oil and re-check as necessary until the proper level has been achieved. Then re-install the dipstick and filler cap and install the engine cover to complete the procedure.

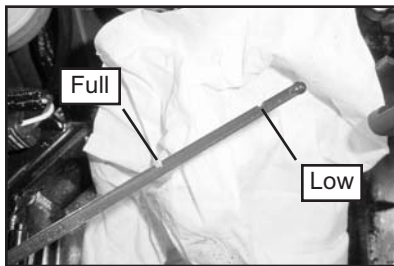
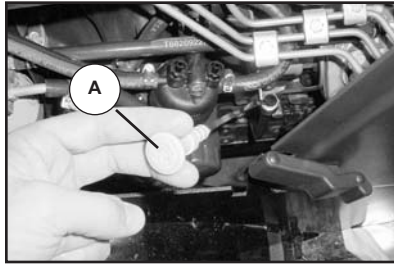



Water Separator

The water separator removes water from the fuel supply as the engine runs. Drain the water separator daily to maintain proper function.

To drain the water separator:

1. Loosen the twist valve on the bottom of the separator.
2. Retighten the valve once all of the water has been drained from the catch bowl.

Accessory Belts

The engine uses a belt to drive accessories like the alternator, water pump, and cooling fan. Belts typically stretch and wear during their service life. As a result, the accessory belt on the ST-50 should be visually inspected daily for tension, condition, and presence prior to operating your machine.

To check drive belt:

1. With the engine off and cool, remove the key from the ignition to avoid accidental start.
2. Remove the engine cover from the machine.
3. Visually inspect the belt to make sure it is present, tight on the pulleys and in good condition.



Fuse Panel

The electrical system in the ST-50 is equipped with fuses that protect the electrical components from damage. They can be found in the fuse panel located beneath the passenger seat.

In the event of an electrical malfunction, the most logical place to start is the fuse panel. Check the fuse(s) related to the problem you are having and inspect it. If the fuse filament appears broken, black or burned, it needs to be replaced. Replace fuses with the correct amperage replacement fuse only. Replacing a fuse with one of a higher amperage rating may burn out the electrical component the fuse was meant to protect. See the troubleshooting section of this manual for an additional resource to aid in tracking suspected electrical problems.

MAINTENANCE

Hydraulic System

Hydraulic Fluid / Filter Change

Hydrostatic components require extremely clean oil in order to have a long service life. Use extreme caution when changing the hydraulic oil. Introducing dirt or debris could be detrimental to the hydraulic system. ASV recommends service intervals of 500 hours for hydraulic fluid and 250 hours for hydraulic filter.

To change the hydraulic fluid:

1. Remove the belly pan that mounts between the torsion axles to access the hydraulic tank drain.
2. Locate the hydraulic system drain in the center of the exposed portion of the tank just in front of the rear torsion axle.
3. Remove the drain plug using the correct size wrench to avoid damaging the drain plug. (fig. 1)
4. Drain the hydraulic fluid into a suitable catch container.
5. Remove access cover in the cargo bed behind the passenger seat to access the hydraulic reservoir. (fig. 2)
6. Locate the hydraulic filter housing beneath the access cover.
7. Thoroughly clean around the filter housing to prevent dirt or debris from entering the system.
8. Remove the bolts securing the filter housing cover to the housing, then remove the cover. (fig. 3, 4)

9. Remove the filter from the housing and replace it with a new one. (fig. 5)
10. Reverse steps 3 and 8 to close the system.
11. Open the passenger side access door to the rear console enclosure (behind the seats) and remove the hydraulic oil filler cap. (fig. 6)
12. Fill the hydraulic system with ASV Premium All Season MV Hydraulic Oil or equivalent until the full mark on the dip stick has been reached (fig. 6, 7).
13. Start the engine and operate the hydraulic circuits to work any trapped air out of the system.
 - Drive the machine forward and backward.
 - Turn the steering wheel left and right while in motion.

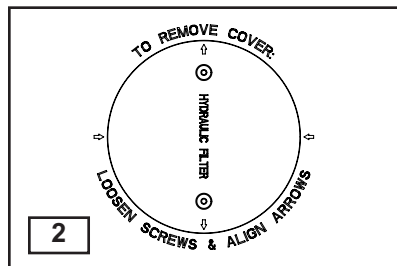
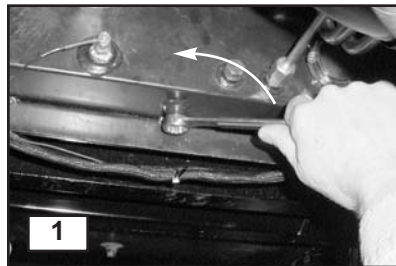

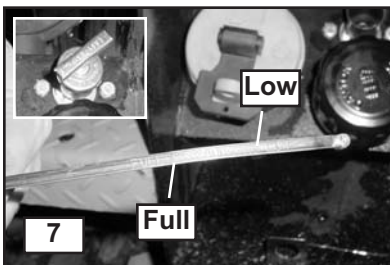
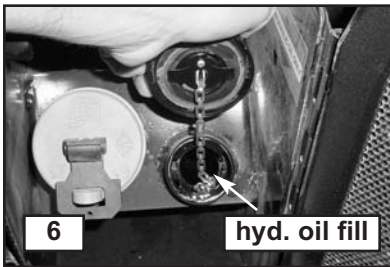
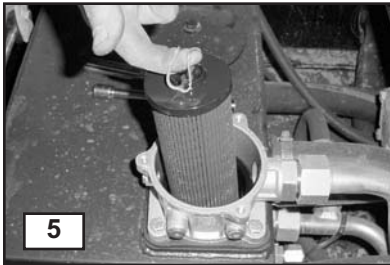
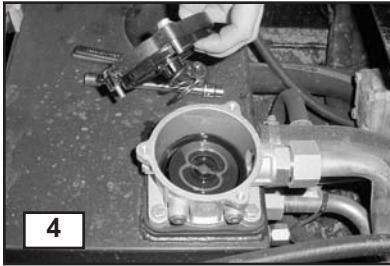
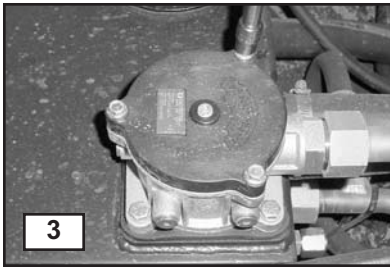

Undercarriages

The undercarriage assemblies typically operate in harsh working conditions. They may work in mud, gravel, debris and various other abrasive materials during operation. ASV recommends a daily inspection of the undercarriage assemblies and cleaning if necessary.

Materials that are particularly sticky or abrasive like clay, mud, or gravel should be cleaned from the undercarriages more often to minimize component wear. A pressure washer works well for cleaning materials from the undercarriages. At times when a pressure washer is not available, use a bar, shovel or similar device to remove foreign materials.

When cleaning, pay particular attention to the drive motors/sprockets and the front wheels where debris is likely to accumulate. If traversing scrap or debris, inspect more often and remove foreign objects that may wrap around or lodge themselves between components causing premature wear and damage.

Operating in loamy sand or on turf or other finished surfaces may require less frequent cleaning, but daily inspection is still advised.

MAINTENANCE

Undercarriages

Grease Fittings

The undercarriages are equipped with grease fittings at the main torsion axle pivot points. Lubricate fittings daily or after every 10 hours of operation to ensure proper operation and maximize component life.

Track Tension

Proper track tension must be maintained for optimal performance and track/undercarriage life. Running a track that is too loose may cause the track to misfeed, possibly causing damage to the track and or undercarriage components. Running a track that is too tight may cause track stretch, premature bearing failure, or other preventable damage to the machine. Tracks should only be tightened to the point where there is no visible sag (when viewed from the side) between the rear sprocket and the front idler wheels. Never tighten the tracks beyond this point.

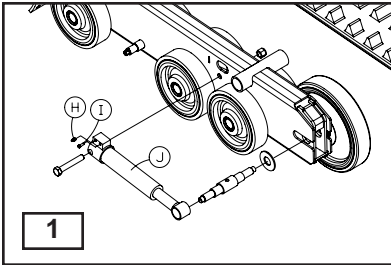

Adjustment

To tighten tracks:

1. Locate the input grease zerk (H) on the tensioner unit (J) mounted within the frame rail. (fig. 1)
2. Connect a grease gun to the zerk and inject grease into the tensioner until the track is properly tensioned.

The track tension adjustment procedure is now complete.

If for some reason the tracks are too tight, loosen them until tension is correct.

To loosen tracks:

1. Locate the grease bleeder bolt (I) adjacent to the input zerk on the tensioner unit. (fig. 1)
2. Using a socket wrench and extension, loosen the bleeder bolt slowly until grease begins to flow out from around the bolt. Allow grease to bleed out until track tension is correct.

Note: During the first 50 hours of operation the tracks will "break-in" and will most likely require adjustment.

Track Removal

The rubber tracks may need to be removed periodically to inspect undercarriage components or for replacement if worn or damaged.

To remove tracks:

1. Raise the machine off of the ground and mechanically support it on ASV jack stands at a height that allows just enough clearance for track removal. The recommended distance is 3-4" from the bottom of the track to the ground.
2. Remove the outer snap ring and grease cover on the outer front 14" idler wheel (fig. 2, 3). Then remove the nut and washer from the axle (fig. 4, 5). Leave the wheel in place for now.
3. Loosen the bleeder bolt (I) on the grease tension unit (J) and allow grease to flow out until the front wheels are almost touching the 10" wheels behind them (fig. 1). Then tighten the bleeder bolt to hold them in place (fig. 6). This will put slack in the track and allow the two front 10" wheels to be removed (fig. 7).

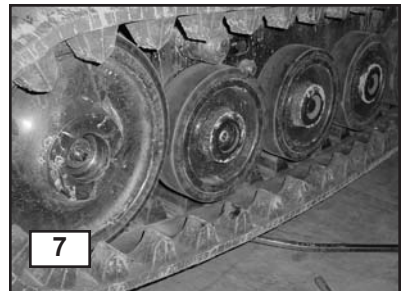
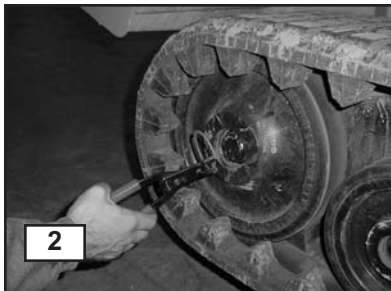

MAINTENANCE

Undercarriages

4. Remove the two front 10" diameter wheels (second wheel back in the undercarriage from the front) by first removing the outer snap rings and grease covers (fig. 8, 9). Then remove the nuts securing the wheel assemblies to the axle (fig. 10). Then remove the wheels (fig. 11, 12).

Note: A pry bar may be useful in helping to free the wheels from the axles for removal.

5. Loosen the bleeder bolt once again and move the front 14" wheels and axle as far rearward as possible. It may be necessary to assist in sliding the wheels rearward by stepping down on the inside of the track as shown (fig. 13).
6. Grab hold of the track and the outer front 14" wheel, then pull them off of the undercarriage together, from the inside to the outside of the machine (fig. 14, 15).

Note: Keep the 14" wheel center in line with the axle as much as possible during wheel/track removal to avoid damaging the inner wheel seal as it passes over the threads on the axle shaft.

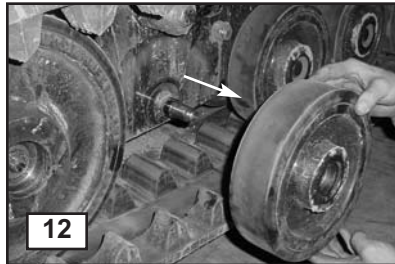
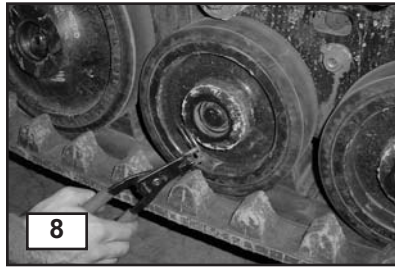

Note: The outer bearing on the 14" wheel will most likely fall out of the wheel as you remove it from the undercarriage. Make sure to remove it or catch it if possible to keep it clean (fig. 16).

7. Pull the track the rest of the way off of the undercarriage at the rear of the machine (fig. 17).

Repeat this procedure if necessary on the other side of the machine.

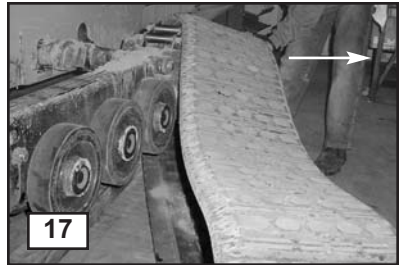
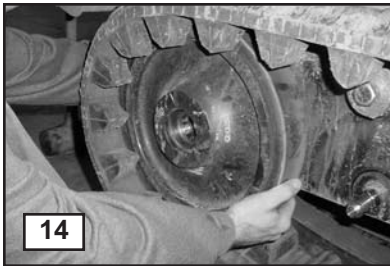
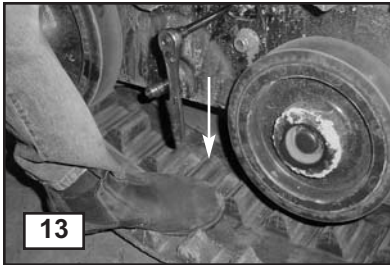

MAINTENANCE

Undercarriages

To install tracks:

1. Wrap the track around the sprocket at the rear of the undercarriage (fig. 1).
2. Lubricate the inner front 14" wheel and the inside of the track at the front to aid in sliding the track back onto the undercarriage (fig. 2, 3). Wipe the axles clean (fig. 4).
3. Install outer 14" wheel into the track between the drive lug rows, then pull or pry the wheel forward to line it up with the axle, then slide it onto the axle as you slide the track over the inner 14" wheel. Once on the axle, tap the wheel gently inward into position (fig. 5, 6, 7).

Note: It is important to align the wheel center with the axle prior to sliding it on to avoid damaging the inner seal during installation.

Note: If for some reason your machine is higher off of the ground than recommended, you may need to raise the lower portion of the track upwards towards the undercarriage in order to gain the slack needed to perform step 3.

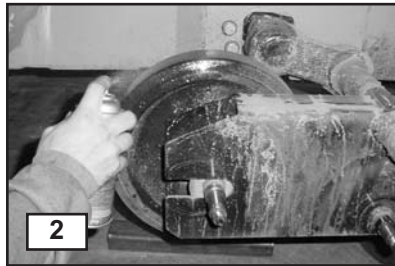
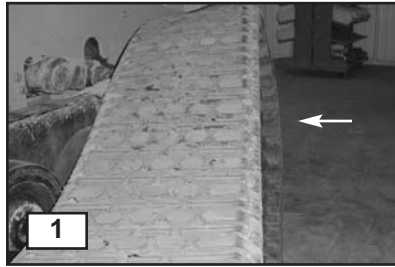

4. Clean and reinstall (repack with grease if necessary) the outer bearing into the 14" wheel (fig. 8).
5. Reinstall the washer and lock nut and tighten to secure the 14" wheel in place. Do not install the grease cover or snap ring yet (fig. 9, 10).

Note: The markings (indentations) on the lock nut face should be visible from the outside of the wheel during installation. This indicates proper orientation of the nut on the axle.

6. Tighten the bleeder bolt and attach a grease gun to the input zerk. Pump grease into the tensioner unit until the 14" wheel is just far enough for ward to install the 10" wheel (fig. 11).

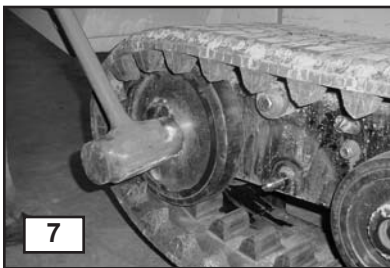
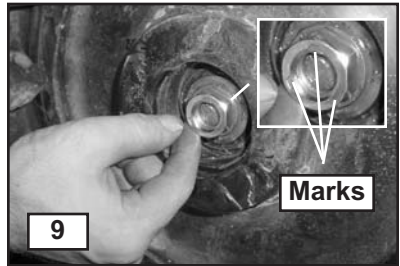

MAINTENANCE

Undercarriages

7. Install the inner and outer 10" wheels and secure them in position with their nuts, grease covers and snap rings (fig. 12, 13).
8. Attach a grease gun to the input zerk and pump grease into the tensioner unit until there is no visible sag in the track when viewed from the side (fig. 14, 15).
9. Retighten the nut on the outer 14" wheel, then install the grease cover and snap ring (fig. 16, 17, 18).

Repeat this procedure if necessary on the other side of the machine.

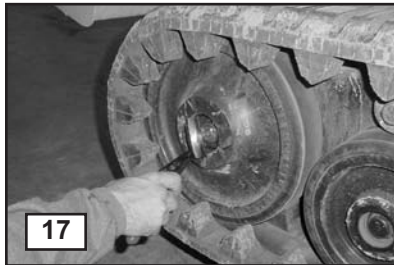
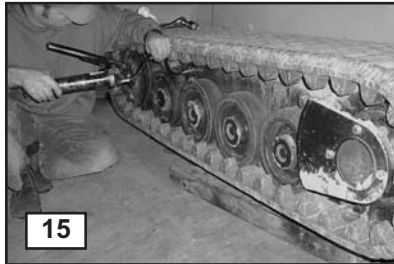

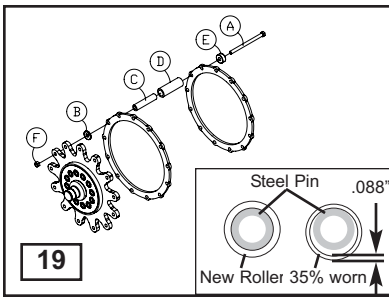

Drive Sprocket Rollers

ASV undercarriages utilize rollers on the drive sprockets to drive the track. These rollers help minimize friction between the track and the drive sprocket to prolong track life. The rollers rotate around hardened steel pins and usually wear on their inside surfaces.

As they wear, the rollers become thinner, but will continue to function as long as they rotate freely around the pins.

Sprocket rollers should be inspected every 50 hours of operation and replaced if cracked or worn to less than 35% of original thickness. (.088")

Roller Replacement

Turn the engine off, remove the key from the ignition and disconnect battery prior to performing this procedure.

To replace worn rollers:

1. With the machine turned off and parked in a safe working area, remove the track to expose the sprocket for roller replacement. (see page 40)

2. Remove one bolt (A) holding washer (B), steel pin (C), roller (D), and external roller (E) in place. The pin and roller may then be removed from the sprocket. (fig. 19)
3. Install a new roller over the pin.
4. Slide the bolt back through the sprocket, washer, pin, and external roller. (fig. 19)
5. Install and tighten the retaining nut (F).
6. Repeat this procedure as required throughout the sprocket.
7. Reinstall the track. (pg. 43)
8. Repeat this procedure on the other side of the machine if necessary.
9. Perform the track tension adjustment procedure. Roller replacement is now complete.

Note: ASV recommends replacing external rollers as a set to simplify inspection and maintain proper sprocket function.

Note: Internal pins should be inspected when replacing rollers. Internal pins do not rotate during operation and may experience uneven wear. Replace if worn to less than 35% of original thickness.

TROUBLESHOOTING - CONTENTS

Overview/No-Start	49
Hydraulics/Electrical/Overheat	50

Overview

The most effective way to prevent a malfunction from occurring is to closely follow the recommended maintenance schedule and instructions throughout the life of the machine. However, if a malfunction does occur, finding the problem and fixing it quickly are important. This section covers a select set of symptoms that may occur and suggests possible causes.

Problem

Machine will not crank over.

Possible causes:

1. Continuous flow switch activated.
2. Battery cables loose or corroded.
3. Ignition fuse blown.
4. Main starter fuse blown.
5. Starter relay malfunctioning.
6. Weak or dead battery.
7. Faulty continuous hydraulic flow switch.
8. Faulty ignition switch.
9. Faulty starter.
10. Loose, broken or disconnected wiring at key, relay or starter.
11. Main power fuse (60/80 amp) blown.

Problem

Machine cranks, but will not start.

Possible causes:

1. Fuel tank empty, fuel filter plugged or fuel line restricted.
2. Battery discharged (engine rotates slowly).
3. Injection pump fuse blown.
4. Power relay (B) fuse blown. (50 amp)
5. Faulty power relay (B).
6. Loose, broken or disconnected wiring at injection pump or fuse.
7. Glow plugs not pre-heating (look for black smoke).
 - a) Main glow plug fuse blown.
 - b) Glow plug relay malfunctioning.
 - c) Loose, broken, or disconnected wiring at ignition switch, relay or glow plug ground strip.
 - d) Faulty glow plugs.
8. Faulty ignition switch.
9. Loose, broken or disconnected wiring in starting circuit.
10. Loose, broken or disconnected wiring at fuel shutdown solenoid.
11. Air in fuel system, or defective fuel injection pump.

Problem

Machine starts, but hydraulics will not operate.

Possible causes:

1. Operator not in seat.
2. Push to operate switch not activated.
3. Seat belt(s) not fastened.
4. Safety relay fuse for seat belt and operator presence safety switches blown.
5. Faulty seat belt safety switch.
 - a) Test for continuity through operator presence and seat belt switches. Adjust or replace as necessary.
6. Loose, broken or disconnected ground wires (check ground connections.)
7. Faulty safety relay.
8. Faulty safety solenoid or safety solenoid spool.
9. Loose, broken or disconnected wiring at fuse, relay, or safety solenoid.
10. Low charge pressure.

Problem

Battery will not accept or maintain charge.

Possible causes:

1. Loose alternator belt.
2. Alternator fuse blown.
3. Faulty alternator diode.
4. Loose, broken or disconnected wiring at battery, alternator, diode or fuse.
5. Excessive current draw with key in "off" position.
6. Faulty battery.
7. Faulty alternator.

8. Faulty resistor. (on back of fuse panel)

Problem

Hydraulic oil light illuminated; hydraulic system overheating.

Possible causes:

1. Debris plugging oil cooler, limiting airflow.
2. Low hydraulic oil level.
3. Loose or missing fan belt.
4. Damaged or missing cooling fan blades.
5. Incompatible attachment.
 - a) Attachment must match machine flow capabilities.
 - b) Attachment hose inside diameter must be at least 1/2".
6. Faulty hydraulic oil temperature sending unit.
7. Faulty quick coupler.
8. Cooler bypass relief open.

Note: Cooler bypass should open at 80 PSI.

Problem

Engine coolant temperature light illuminated; engine overheating.

Possible causes:

1. Low coolant level.
2. Debris plugging radiator, limiting airflow.
3. Damaged or missing cooling fan blades.
4. Loose or missing fan belt.
5. Faulty engine coolant temperature warning light.

MACHINE SPECIFICATIONS

General Dimensions

ST-50

Machine width:	66 in. / 1,676 mm
Ground clearance:	9.25 in. / 235 mm
Machine length:	117 in. / 2,972 mm
Height to top of ROPS:	72 in. / 1,829 mm

Track Specifications

Track width:	15 in. / 381 mm
Length of track on ground:	59 in. / 1,499 mm
Ground contact area:	1,770 in. ² / 1.14 m ²

Machine Weight

*Operating weight:	4,562 lb / 2,069 kg
Shipping weight:	4,220 lb / 1,914 kg
*Ground pressure:	2.56 psi / 17.6 kPa

Engine

Model:	Perkins 404C-22
Type:	4-cylinder diesel
Displacement:	134 in. ³ / 2.2 liter
Gross HP @ 2800 rpm:	50 hp / 37.3 kW
Torque (peak):	105 ft-lb / 143 Nm

Operating Specifications

Cargo bed capacity:	4,000 lb / 1814 kg
Maximum speed low range:	6.5 mph / (10.5) kmh
Maximum speed high range:	11.5 mph / (18.5) kmh

Auxiliary Hydraulic Pump

Continuous flow, max.:	16.3 gpm / 61.7 lpm
Pressure:	3,000 psi / 20,670 kPa

Service Refill Capacities

Fuel tank:	30 gal / 113.6 L
**Hydraulic tank:	5.125 gal / 19.4 L
**Engine coolant:	1.75 gal / 6.62 L
**Engine oil, including filter:	11.2 qt / 10.6 L

Specifications are subject to change without notice.

** Fluid levels full, 165 lb. operator seated in cab.*

*** When replacing or replenishing fluids, it is recommended that you specify genuine ASV products from your ASV dealer.*

CALIFORNIA PROPOSITION 65

California (U.S.A.) state law stipulates that manufacturers of machines operated within its borders must provide a clear warning to customers regarding exposure to substances commonly associated with the machine that are recognized by the state as harmful. Terex/ASV complies with this requirement by providing the following information.

CALIFORNIA Proposition 65

Warning: This product contains lead and lead compounds, diesel engine exhaust, and used engine oil, chemicals known to the state of California to cause cancer.

CALIFORNIA Proposition 65

Warning: This product contains lead, a chemical known to the state of California to cause birth defects or other reproductive harm.

RECOMMENDED FLUIDS

When replacing or replenishing the fluids and lubricants in your Rubber Track Utility Vehicle, you can specify ASV products. This ensures that the new fluids and lubricants match those originally installed when your machine left the ASV factory. ASV products were developed for, tested and approved by ASV to assure optimum life and performance in all ASV Rubber Track Equipment, when used as recommended.

The ASV product line includes:

- Heavy Duty Engine Oil, 10W-30
- Premium All Season MV Hydraulic Oil
- Multi-Purpose EP Lithium Grease
- Long-Life 50/50 Antifreeze/Coolant
- Undercarriage Wheel Bearing Lubricant.

ASV fluids and lubricants are available through your ASV Dealer. If ASV products are not available, use high quality substitutions that meet or exceed the specifications listed above and throughout this manual.

Fuel Specifications

In North America, diesel fuel, distilled from crude oil, identified as No. 1-D or No. 2-D in “ASTM D975” generally meet machine requirements.

STANDARD TORQUE GUIDELINES

Inch Fasteners

Thread size	Standard Torque
1/4"	9 +/- 2 lb ft
5/16"	18 +/- 4 lb ft
3/8"	35 +/- 7lb ft
7/16"	50 +/- 11 lb ft
1/2"	75 +/- 15 lb ft
9/16"	120 +/- 22 lb ft
5/8"	160 +/- 30 lb ft
3/4"	275 +/- 37 lb ft
7/8"	460 +/- 60 lb ft
1"	660 +/- 75 lb ft
1-1/8"	960 +/- 110 lb ft
1-1/4"	1320 +/- 150 lb ft
1-3/8"	1780 +/- 220 lb ft
1-1/2"	2280 +/- 260 lb ft

Machine Specific Fasteners

Drive Sprocket Roller Bolts/Nuts

Torque to: 88 +/- 10 Ft./Lbs.

Drive Sprocket Retaining Bolts

Torque to: 160 +/- 10 Ft./Lbs

Metric Fasteners

Thread size	Standard Torque
M6	12 +/- 3 Nm
M8	28 +/- 7 Nm
M10	55 +/- 10 Nm
M12	100 +/- 20 Nm
M14	160 +/- 30 Nm
M16	240 +/- 40 Nm
M20	460 +/- 60 Nm
M24	800 +/- 100 Nm
M30	1600 +/- 200 Nm
M36	2700 +/- 300 Nm

Terex Construction Americas

8800 Rostin Road

Southaven, MS 38671

(888)-201-6008

(662)-393-1800

www.terex.com